



(Sizes 1/2"-6") **124-01**
(Full Internal Port)
MODEL
(Sizes 3"-8") **624-01**
(Reduced Internal Port)

Float Valve (Sizes 1/2"-8")



- Accurate and Repeatable Level Control
- On-Off or Non-Modulating Action
- Fully Adjustable High and Low Level Settings
- Simple Design, Proven Reliable
- Easy Installation and Maintenance

The Cla-Val Model 124-01/624-01 Float Valve is a non-modulating valve that accurately controls the liquid level in tanks. This valve is designed to open fully when the liquid level reaches a pre-set low point and close drip-tight when the level reaches a preset high point.

This is a hydraulically operated, diaphragm valve with the pilot control and float mechanism mounted on the cover of the main valve. The float positions the pilot control to close the valve when the float contacts the upper stop. The high and low liquid levels are adjusted by positioning the stop collars on the float rod. The difference between high and low levels can be adjusted to as little as one inch, or to as much as eighteen inches.

Level settings can be as much as eleven and one half feet below the valve. The float mechanism may be located remotely from the main valve. See the technical data sheet on Model CF1-C1 Float Control for additional information.

Schematic Diagram

Item	Description
1	Hytrol (Main Valve)
2	CF1-C1 Float Control

Optional Features

Item	Description
A	X46A Flow Clean Strainer
B	CK2 (Isolation Valve)
C	CV Flow Control (Closing)
F	Independent Operating Pressure
P	X141 Pressure Gauge
S	CV Speed Control (Opening)
V	X101 Valve Position Indicator
Y	X43 "Y" Strainer

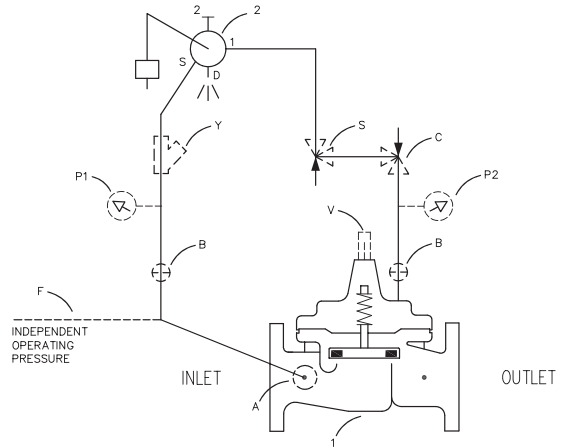

Typical Applications

The Model 124-01/624-01 Float Valve is commonly mounted above the high water level in a tank. Globe pattern valves are supplied standard with the float control mounted on the cover as illustrated, with a horizontal discharge. Angle valves are configured to discharge downward.

Note: We recommend protecting tubing and valve from freezing temperatures.

Installation

A stilling well (8" minimum diameter) must be provided around the float if the liquid surface is subject to turbulence, ripples or wind. When the valve is mounted on top of the tank roof, a 2" clearance hole should be provided for side movement of the float rod where the rod goes through the top of the tank.

An independent source of air or water may be used to operate the valve (option F). The pressure from this independent source must at all times be equal to or greater than pressure at the valve inlet.

If minimum flowing line pressure is less than 10 psi, consult factory.

If the float control is remotely mounted from the main valve, the control may be installed at any elevation above the valve, provided the flowing line pressure in psi is greater than the vertical distance in feet between the valve and the float control. See the technical data sheet on Model CF1-C1 for additional information.

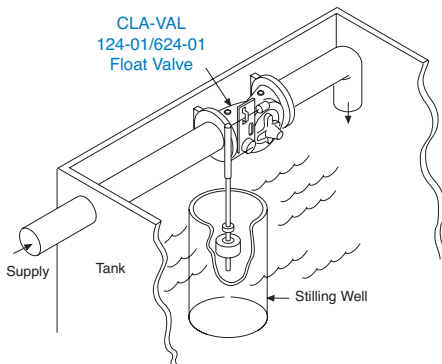

Model 124-01 (Uses Basic Valve Model 100-01)

Pressure Ratings (Recommended Maximum Pressure - psi)

Valve Body & Cover		Pressure Class			
		Flanged			Threaded
Grade	Material	ANSI Standards*	150 Class	300† Class	End‡ Details
ASTM A536	Ductile Iron	B16.42	250	640	400
ASTM A216-WCB	Cast Steel	B16.5	285	720	400
ASTM B62	Bronze	B16.24	225	500	400

Note: * ANSI standards are for flange dimensions only.
 Flanged valves are available faced but not drilled.
 ‡ End Details machined to ANSI B2.1 specifications.
 † Consult factory when Maximum Operating Pressure Differential (MOPD) is greater than 400 PSID

Materials

Component	Standard Material Combinations		
Body & Cover	Ductile Iron	Cast Steel	Bronze
Available Sizes	½" - 6"	½" - 6"	½" - 6"
Disc Retainer & Diaphragm Washer	Cast Iron	Cast Steel	Bronze
Trim: Disc Guide, Seat & Cover Bearing	Bronze is Standard Stainless Steel is Optional		
Disc	Buna-N® Rubber		
Diaphragm	Nylon Reinforced Buna-N® Rubber		
Stem, Nut & Spring	Stainless Steel		

For material options not listed, consult factory.
 Cla-Val manufactures valves in more than 50 different alloys.

Dimensions

(In inches)

100-01 (Globe)

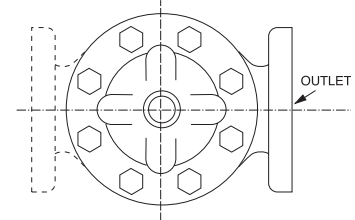
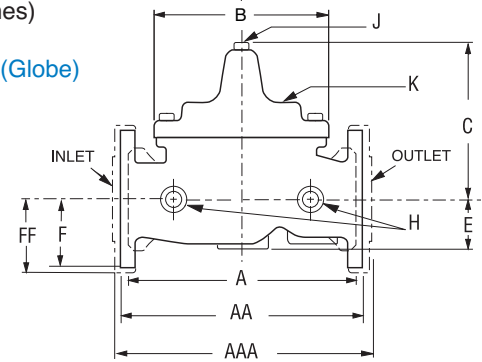

100-01 (Angle)

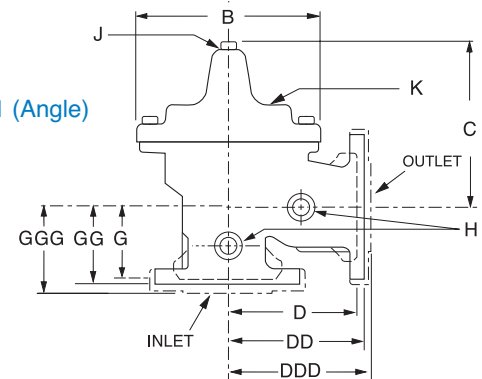

Model 124-01 Dimensions (In Inches)

Valve Size (Inches)	½ - ¾	1	1 ¼-1 ½	2	2 ½	3	4	6
A Threaded	3.50	5.12	7.25	9.38	11.00	12.50	—	—
AA 150 ANSI	—	—	8.50*	9.38	11.00	12.00	15.00	20.00
AAA 300 ANSI	—	—	9.00*	10.00	11.62	13.25	15.62	21.00
B Dia.	3.12	4.38	5.62	6.62	8.00	9.12	11.50	15.75
C Max.	3.00	2.75	5.50	6.50	7.56	8.19	10.62	13.38
D Threaded	—	—	3.25	4.75	5.50	6.25	—	—
DD 150 ANSI	—	—	4.00*	4.75	5.50	6.00	7.50	10.00
DDD 300 ANSI	—	—	4.25*	5.00	5.88	6.38	7.88	10.50
E	0.88	1.63	1.12	1.50	1.69	2.06	3.19	4.31
F 150 ANSI	—	—	2.50	3.00	3.50	3.75	4.50	5.50
FF 300 ANSI	—	—	3.06	3.25	3.75	4.13	5.00	6.25
G Threaded	—	—	1.88	3.25	4.00	4.50	—	—
GG 150 ANSI	—	—	4.00*	3.25	4.00	4.00	5.00	6.00
GGG 300 ANSI	—	—	4.25*	3.50	4.31	4.38	5.31	6.50
H NPT Body Tapping	⅛	¼	⅜	⅜	½	½	¾	¾
J NPT Cover Center Plug	⅛	¼	¼	½	½	½	¾	¾
K NPT Cover Tapping	⅛	¼	⅜	⅜	½	½	¾	¾
Valve Stem Internal Thread UNF	—	—	10-32	10-32	10-32	¼-28	¼-28	¾-24
Stem Travel	—	—	0.4	0.6	0.7	0.8	1.1	1.7
Approx. Ship Wt. Lbs.	3	8	15	35	50	70	140	285

*1½" Size Only

Model 624-01 (Uses Basic Valve Model 100-20)

Dimensions (In inches)

Pressure Ratings (Recommended Maximum Pressure - psi)

Valve Body & Cover		Pressure Class		
		Flanged		
Grade	Material	ANSI Standards*	150 Class	300† Class
ASTM A536	Ductile Iron	B16.42	250	640
ASTM A216-WCB	Cast Steel	B16.5	285	720
ASTM B62	Bronze	B16.24	225	500

Note: * ANSI standards are for flange dimensions only.
Flanged valves are available faced but not drilled.
† Consult factory when Maximum Operating Pressure Differential (MOPD) is greater than 400 PSID

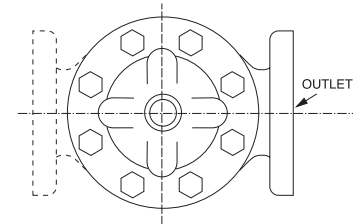
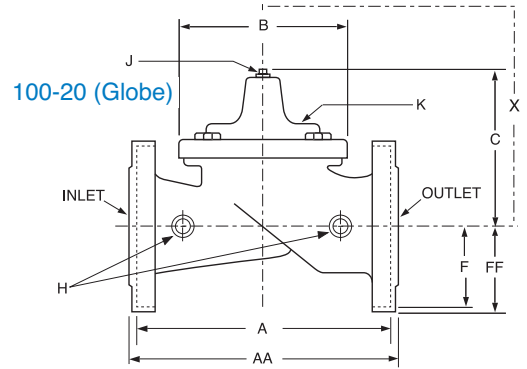

Materials





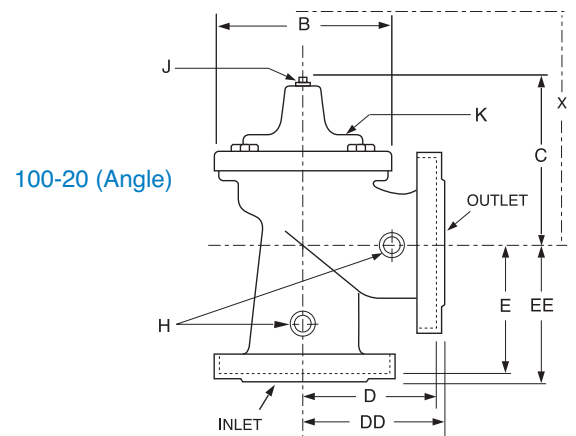





















Component	Standard Material Combinations		
Body & Cover	Ductile Iron	Cast Steel	Bronze
Available Sizes	3" - 8"	3" - 8"	3" - 8"
Disc Retainer & Diaphragm Washer	Cast Iron	Cast Steel	Bronze
Trim: Disc Guide, Seat & Cover Bearing	Bronze is Standard Stainless Steel is Optional		
Disc	Buna-N® Rubber		
Diaphragm	Nylon Reinforced Buna-N® Rubber		
Stem, Nut & Spring	Stainless Steel		

For material options not listed, consult factory.
Cla-Val manufactures valves in more than 50 different alloys.



Model 624-01 Dimensions (In Inches)

Valve Size (Inches)	3	4	6	8
A 150 ANSI	10.25	13.88	17.75	21.38
AA 300 ANSI	11.00	14.50	18.62	22.38
B Dia.	6.62	9.12	11.50	15.75
C Max.	7.00	8.62	11.62	15.00
D 150 ANSI	—	6.94	8.88	10.69
DD 300 ANSI	—	7.25	9.38	11.19
E 150 ANSI	—	5.50	6.75	7.25
EE 300 ANSI	—	5.81	7.25	7.75
F 150 ANSI	3.75	4.50	5.50	6.75
FF 300 ANSI	4.12	5.00	6.25	7.50
H NPT Body Tapping	3/8	1/2	3/4	3/4
J NPT Cover Center Plug	1/2	1/2	3/4	3/4
K NPT Cover Tapping	3/8	1/2	3/4	3/4
Valve Stem Internal Thread UNF	10-32	1/4-28	1/4-28	3/8-24
Stem Travel	0.6	0.8	1.1	1.7
Approx. Ship Wt. Lbs.	45	85	195	330

Valve Selection		These Symbols  and  Indicate Available Sizes*											
		Inches	1/2	3/4	1	1 1/4	1 1/2	2	2 1/2	3	4	6	8
		mm	15	20	25	32	40	50	65	80	100	150	200
		End Detail	Threaded					Threaded & Flanged			Flanged		
Model 124-01	Basic Valve 100-01	Globe											
		Angle											
	Suggested Flow (gpm)	Max. Continuous	19	33	55	93	125	210	300	460	800	1800	
		Max. Intermittent	24	42	68	120	160	260	370	580	990	2250	
	Suggested Flow (Liters/Sec)	Max. Continuous	1.2	2.1	3.5	5.9	8	13	19	29	50	113	
Max. Intermittent		1.5	2.6	4.3	7.6	10	16	23	37	62	142		
Model 624-01	Basic Valve 100-20	Globe											
		Angle											
	Suggested Flow (gpm)	Max. Continuous								260	580	1025	2300
		Suggested Flow (Liters/Sec)	Max. Continuous							16	37	65	145

624-01 is the reduced internal port size version of the 124-01.

For 100-01 basic valves, suggested flow calculations were based on flow through Schedule 40 Pipe. Maximum continuous flow is approx. 20 ft/sec (6.1 meters/sec) & maximum intermittent is approx. 25 ft/sec (7.6 meters/sec). For 100-20 basic valves, suggested flow calculations were based on flow through the valve seat. Approx. 26 ft/sec (7.9 meters/sec) is used for maximum continuous flow.

* See the 124-02/624-02 Technical Data Sheet for larger sizes.

**Flanged End Detail Only

Pilot System Dimensions (In Inches)

We recommend providing adequate space around valve for maintenance work

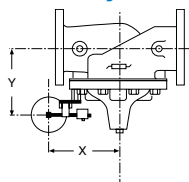

124-01 Float Valve (Globe)										
Size	1/2"-3/4"	1"	1 1/4"-1 1/2"	2"	2 1/2"	3"	4"	6"	8"	
X	2.50	5.50	6.00	6.25	6.75	7.25	8.00	10.25	12.25	
Y	4.25	4.75	6.75	7.00	7.75	8.25	9.50	10.50	10.75	
Z (MAX)*	29.75	28.50	28.25	28.50	28.75	29.00	29.25	29.25	53.25	

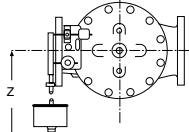

124-01 Float Valve (Angle)							
Size	1 1/2"	2"	2 1/2"	3"	4"	6"	8"
X	6.00	6.25	6.75	7.25	8.25	10.50	12.25
Y	6.75	7.00	7.75	7.06	9.00	10.00	10.00
Z (MAX)*	28.25	28.50	28.75	29.00	29.25	29.25	53.25

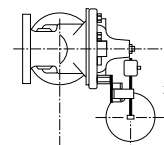

624-01 Float Valve (Globe)				
Size	3"	4"	6"	8"
X	6.25	7.25	8.00	10.25
Y	7.06	7.50	8.75	9.75
Z (MAX)*	28.50	29.00	29.25	29.25

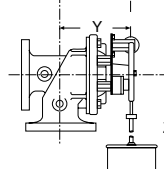

624-01 Float Valve (Angle)			
Size	4"	6"	8"
X	7.25	8.25	10.50
Y	7.50	8.75	9.75
Z (MAX)*	29.00	29.25	29.25

124-01 1/2" to 6"
624-01 3" to 8"
GLOBE

1 1/2" to 8"
ANGLE

*Z(Max.) is with standard float rod.

Pilot System Specifications

Pressure Rating

300 psi Max.

Temperature Rating

Water: to 180°F. Max.

Materials

In contact with operating fluid:
Nylon-reinforced Delrin, Stainless Steel,
Monel, with Buna-N® seals
Float linkage and float rod: Brass and PVC
Base plate: Treated Steel
Float: Polypropylene

Float

5 3/8" diameter. If maximum temperature exceeds 160°F. specify stainless steel float and rod. Available at additional cost.

Float Rod

Standard: Two 12" sections PVC rod, 6" & smaller 12" extension increments at additional cost. Larger counterweight required if float rod length exceeds 5'.
Optional: 24" stainless steel rod, with 24" extension increments at additional cost. Larger counterweight required if float rod length exceeds 2'.

Adjustment Range

Level Differential:
1" min. to 18" max. with PVC rod.
1" min to 40" max. with stainless steel rod.

Operating Fluids

Clean liquids or gases compatible with specified materials.

When Ordering, Please Specify

1. Catalog No. 124-01 or No. 624-01
2. Valve Size
3. Pattern - Globe or Angle
4. Pressure Class
5. Threaded or Flanged
6. Float Rod Material and Length
7. Float Ball Material
8. Desired Options
9. When Vertically Installed



CLA-VAL

PO Box 1325 Newport Beach CA 92659-0325
Phone: 949-722-4800 • Fax: 949-548-5441

CLA-VAL CANADA

4687 Christie Drive
Beamsville, Ontario
Canada L0R 1B4
Phone: 905-563-4963
Fax: 905-563-4040

CLA-VAL EUROPE

Chemin des Mesanges 1
CH-1032 Romanel/
Lausanne, Switzerland
Phone: 41-21-643-15-55
Fax: 41-21-643-15-50

©COPYRIGHT CLA-VAL 2010 Printed in USA
Specifications subject to change without notice.

www.cla-val.com

Represented By: